

|  | PART NO. | FEATURES |
|--|--|---|
| | WORSI32-P-N standard lens, PIR, 347Vac, 2-pole, photo sensor | <ul style="list-style-type: none"> Commercial grade components for long term reliability Straightforward wiring for quick installation Factory configured for the most common applications |
| | WORSI32-P-N extended range lens, PIR, 347Vac, 2-pole, photo sensor | <ul style="list-style-type: none"> DIP switches and dials for advanced functionality Photo Sensor for Natural Daylight control |

Operation
 Diversa 347Vac sensors draw control power directly from the lighting circuit they are intended to control. When in operation the sensor will detect initial motion using Passive Infrared (PIR); once motion is detected, the internal contact will close. Motion through PIR is used to maintain the occupied condition as long as occupants remain within coverage range of Sensor.

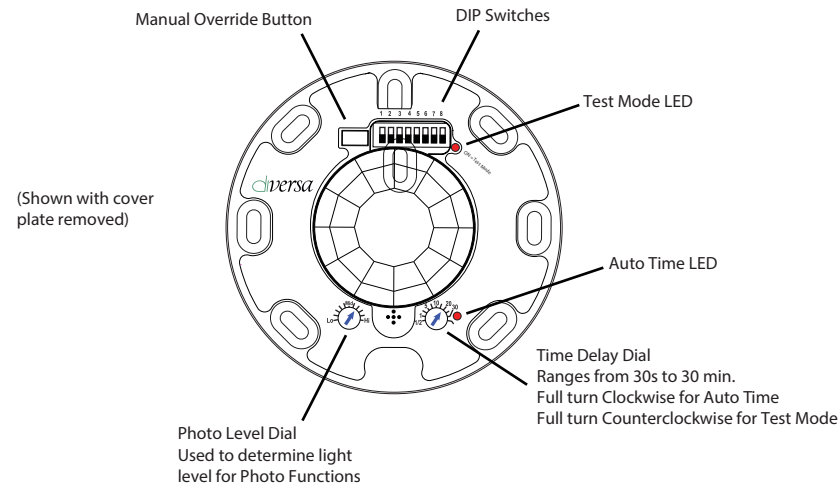

Wiring Instructions

Diversa 347Vac sensors include #14AWG wiring leads. Use appropriate sized wire nuts for connecting wires.

CAUTION: Turn power off at the circuit breaker before working on sensor. According to NEC 240-83(d), if the branch circuit breaker is used as the main switch for a fluorescent lighting circuit, the circuit breaker should be marked SWD. All installations should be in compliance with National Electric Code (NEC) and all state, provincial, federal, and local codes.

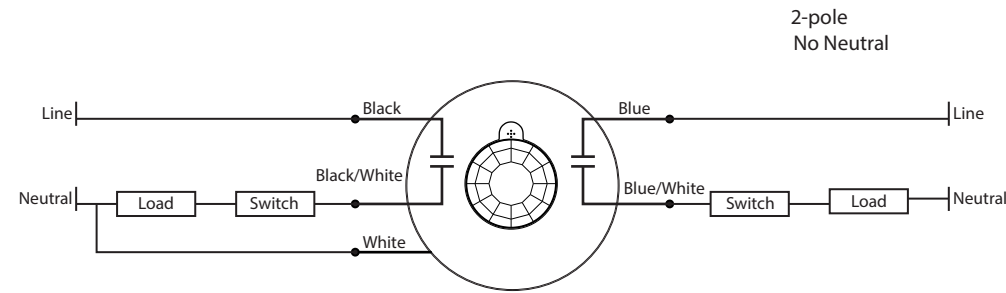

Sensor Location Guidelines

To optimize the performance of Diversa Sensors, please review the coverage pattern, range, and model to match with the application. Room dynamics will change when people and furniture are occupying the space. In some rooms, after move in, some sensors may require adjustments.

- Ensure that the sensor is at least 30 inches away from air handlers/registers and not pointed directly at windows
- Check that you are installing the right product (check the product model number) as per the drawings

Sensor Location Guidelines for "P" models

- Place outside the direct cone of light from fixtures
- Between 3 to 12 feet from windows
- As close as possible to the fixture being controlled
- Above the least illuminated space in the work area
- Away from lighting that is not being controlled by the sensor

Installation

Installing in Smaller Room (Standard Lens)

- Locate the sensor near the entrance door wall to prevent it from viewing out into the hallway.
- Positioning the sensor in this manner ensures that an occupant moves across the longest detection beam upon entrance, utilizing the sensor's maximum PIR range.
- Optimal usage is to detect small motions such as hand movements
- Designed for a mounting height of 7-15 ft

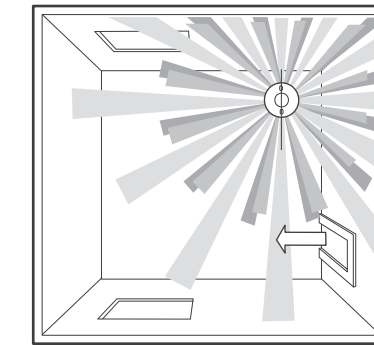

Typical Enclosed Office

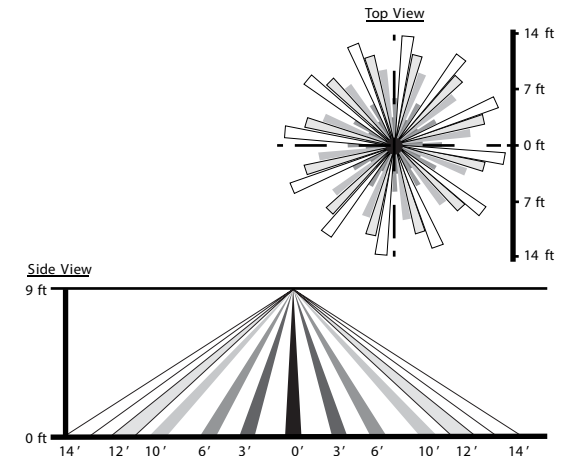

Extended Lens for Larger Rooms

- Place the sensor near the center of the room ceiling. Locate it so the approximate distance of 27ft in or in dead center of room.
- Tilt the lens to aim the detection zone to the bottom of the door.
- Positioning the sensor in this manner ensures that the beam does not reach outside the room without reducing sensitivity.
- Optimal usage is to detect large motions such as walking.
- Designed for a mounting height of 7-15ft.

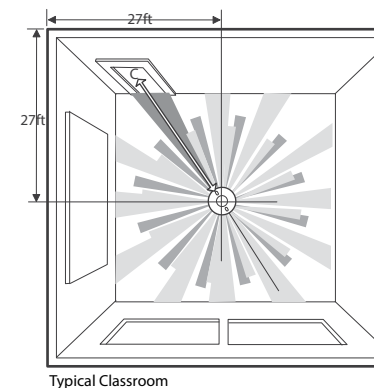

Typical Classroom

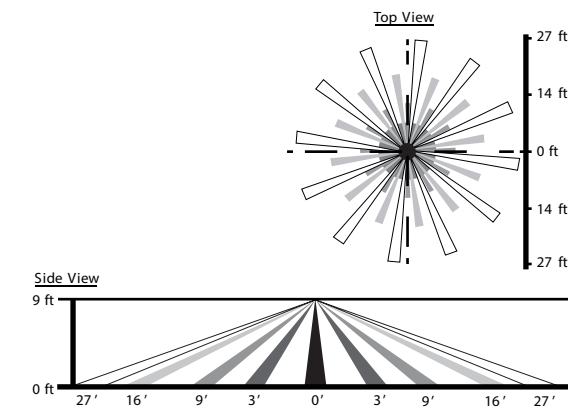

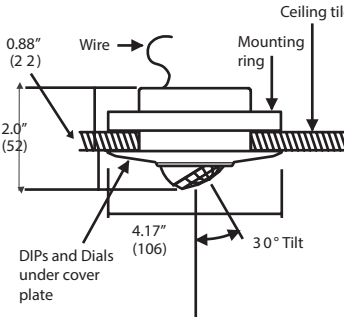
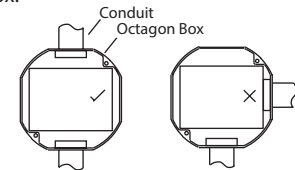
| SPECIFICATIONS | DIMENSIONS/MOUNTING inches (mm) |
|---|---|
| Power • 347Vac • 60Hz | <ul style="list-style-type: none"> Unit attaches to mounting ring with screws or it can be mounted into an octagon box. |
| Contact Ratings • 347Vac - 800W |  |
| Power Consumption • 5.7mA | <ul style="list-style-type: none"> The WOR sensor will fit an octagon box. It is very important that conduits be attached at opposite ends of the box. |
| Approvals • Certified to UL 508, UL244A, CSA C22.2 #14 |  |
| Environment • Indoors, stationary, non-vibrating, non-corrosive atmosphere and non-condensing humidity • Ambient Operating Temperature: 32°F to 104°F (0°C to 40°C) • Storage Temperature: -14°F to 140°F (-25°C to 60°C) | <ul style="list-style-type: none"> Use a 2 1/8" or more, deep box. If the box is less, use the spacer ring. |

General Programming Instructions

This covers mode programming using the onboard DIP and Dial switches.

Factory Defaults

All DIP switches in DOWN position. Time delay: 10 minutes; Natural Daylight level: 50% (200 lux).

*****NOTE*****

Diversa Occupancy Sensors with a "P" in the model number contain a Photo Sensor that is controlled by DIP 6. The factory default for Natural Daylight Mode = ENABLED (DIP 6 DOWN). This mode disables the Manual Override Button. To test sensor functionality, you may need to disable Natural Daylight Mode (DIP 6 UP) to test sensor functionality.

- Start with the PIR Sensitivity at Medium (DIP 5 DOWN)
- To set the light level at which you want to prevent the sensor from turning light ON, rotate Light Level Dial to adjust the light level
- To enable Restroom Mode, ensure that DIP 8 is UP. In this mode Pole 2 will remain on 50% longer than Pole 1 (time is set with the Time Dial) and Pole 2 cannot be Photo Inhibited

DIP Switches & Dial Settings

| Some DIP Switches Control Optional Features Not Found on All Products | | | | |
|---|------------------------------------|---------------------|---------------------|---------|
| DIP # | Function | UP | DOWN | Default |
| 1 | PIR LED | Disabled | Enabled | DOWN |
| 2 | Walk-Through Mode | Enabled | Disabled | DOWN |
| 3 | Manual Override | Disabled | Enabled | DOWN |
| 4 | Sensor Mode | Manual ON (Vacancy) | Auto ON (Occupancy) | DOWN |
| 5 | PIR Sensitivity | High | Medium | DOWN |
| 6 | Natural Daylight Mode ("P" Models) | Disabled | Enabled | DOWN |
| 7 | Not used | Inactive | Inactive | DOWN |
| 8 | Restroom Mode (2-pole models) | Offset | Synchronized | DOWN |

Factory DIP & Dial Settings

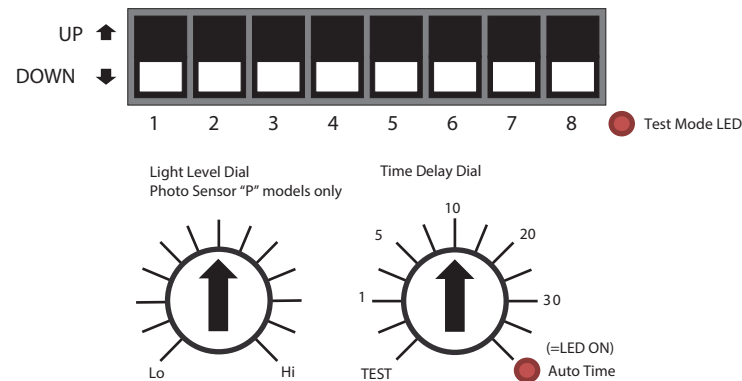

DIP Switch Modes

DIP 1 - PIR Detection LED

LED in Sensor's PIR window flashes GREEN when PIR detects motion. LEDs can be turned OFF with DIP switch. Sensor continues to function.

DIP 2 - Walk-Through Mode

When Enabled and Occupancy switches lights to ON and sensor does not detect motion after 30 seconds of light ON, an OFF Time Delay of 3 minutes is used (OFF Time Delay must be greater than 3 minutes). If motion is detected after 30 seconds of lights ON, the configured OFF Time Delay is followed.

DIP 3 - Manual Override

Manual Override Button can be disabled with DIP switch to prevent manual ON/OFF.

DIP 4 - Sensor Mode

Vacancy Mode - Lights must be turned ON manually when entering a room and are automatically turned OFF when occupancy no longer detected. Maximizes energy savings because lights are only turned on when lighting is required.

Occupancy Mode - Automatically turns lights ON when occupancy is detected in a room and automatically turns lights OFF when occupancy is no longer detected. This is a very convenient mode as lighting controls never have to be touched. Because lights are always turned on when Occupancy is detected regardless of the need for lighting, this is less energy efficient than Vacancy Mode.

DIP 5 - PIR Sensitivity

Can be moved from Medium sensitivity (default) to High sensitivity if sensor is not recognizing Occupancy.

DIP 6 - Natural Daylight Mode ("P" models)

When ENABLED, lights ON when Occupancy detected AND daylight level is below Light Level Dial setting. With lights ON, an increase in daylight above the Light Level Dial setting will not force lights OFF.

DIP 7 - Not Used

DIP 8 - Restroom Mode (2-pole models)

Pole 1 and Pole 2 are set to synchronize to the same Photo and Time Delay settings. With Restroom Mode = Offset, Pole 2 will activate at the same moment as Pole 1 when Occupancy detected; however, Pole 2 will be offset so that OFF delayed 50% longer than Pole 1. (e.g. Light is Pole 1 and Fan is Pole 2. Fan would stay ON 50% longer than light).

Auto Time Mode

Activated when Time Delay Dial is set to Auto Time. Red LED indicator will be ON. In this mode, time delay will start automatically set by the sensor learning occupancy patterns.

Test Mode

Activated when Time Delay Dial is set to TEST. Test Mode LED will flash red for 5 minutes, providing a short Time Delay when testing the installation to determine if the sensor is working as intended or requires adjustments. After 5 minutes, LED will stop flashing and Time Delay reverts to Factory Time Delay setting (10 minutes).

Troubleshooting

Before calling Technical Support, please review the following Troubleshooting Guide.

| Issue | Possible Cause | Recommended Solution |
|--|---|---|
| Lights will not turn ON automatically | Sensor is set to Manual ON Mode. | Check DIP 4. Move DOWN for Auto ON. |
| | Sensor is set to Natural Daylight Mode (Photo Inhibit) and Sufficient Natural Light is Present. | This only applies to Photo Sensor ("P") models. Check DIP 6. If DOWN, sensor is in Natural Daylight Mode, therefore lights will only turn ON if there is insufficient natural daylight. Rotate the Light Level Dial clockwise pressing the Manual Override Button until the Lights turn ON. Natural Daylight mode can be disabled by moving DIP 6 UP. |
| | Manual Override Button was used to turn lights OFF. | Wait for OFF Time Delay to count down, then with motion detected lights will turn ON. Manual Override Button can be disabled by moving DIP 3 UP. |
| Lights will not turn ON Manually | Power has been interrupted or wiring connection is intermittent. | Check the wiring diagram. Ensure ground is connected. With DIP 1 DOWN, check for motion detection by waving hand in front of sensor lens. Activation LED will blink green. |
| | Sensor is set to Natural Daylight Mode (Photo Inhibit) and Sufficient Natural Light is present. | This only applies to Photo Sensor "P" models. Check DIP 6. If DOWN, sensor is in Natural Daylight Mode; therefore, lights will only turn ON if there is insufficient natural daylight. Rotate the Light Level Dial clockwise pressing the Manual Override Button until the lights turn ON. Natural Daylight mode can be disabled by moving DIP 6 UP. |
| Lights will not turn OFF automatically | Power has been interrupted or wiring connection is intermittent. | Check the wiring diagram. Ensure ground is connected. With DIP 1 DOWN, check for motion detection by waving hand in front of sensor lens. Activation LED will blink green. |
| | Sensor is in Auto Time Mode. | If the Sensor is in AUTO Mode, it may take longer than expected to turn the lights off. Set the Time Delay to 5 minutes and leave space to determine if the Sensor is functioning. The maximum Time Delay is 30 minutes. |
| Lights will not turn OFF Manually | Sensor is being activated by a heat source other than occupant. | Sensor may be detecting heat from HVAC registers or other heat sources. Check Installation location for heat source. Reduce PIR sensitivity by moving DIP 5 DOWN. Move sensor location - see guidelines. |
| | Manual Override Button has been disabled. | Move DIP 3 DOWN to enable Manual Override Button. |